

64PNN063

Revision 1

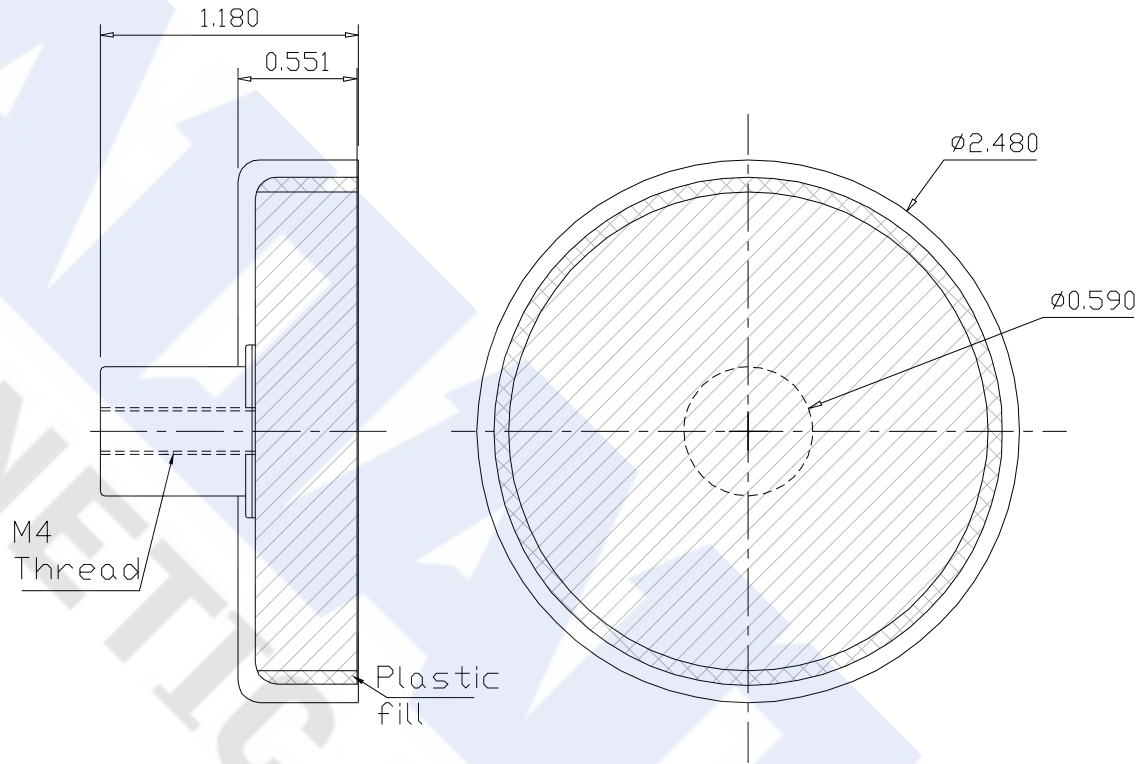

Specifications:

- 1) Ceramic-8 magnet disc
- 2) Nickel coated steel cup and M4 nut
- 3) Magnet surface lower than that of cup 0.005"
- 4) Pull pounds: min. 78 lbs (Tested on a clean, ground steel plate 0.375" thick)
- 5) All dimensions are in inches
- 6) Working temperature range: -40°C~100°C

